



## Fixing Instructions

### Osset Electric Horizontal Radiator



Please unpack your delivery carefully and inspect the radiator and contents – any damages or shortages must be notified to your supplier **within 3 days of delivery** of your goods.

# Specifications

---

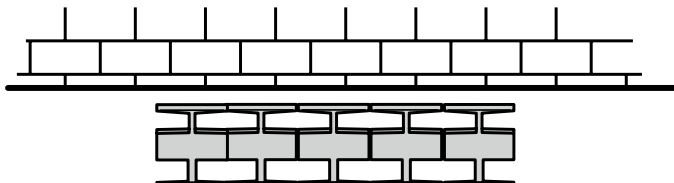
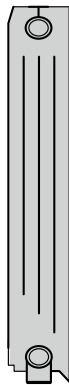
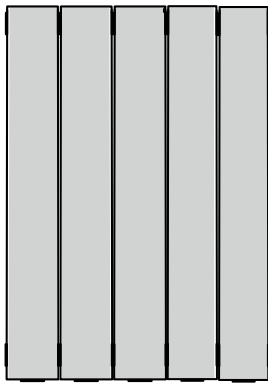

## Technical Information

**Standard connections:** ½"

**Radiator Depth (once installed)**

**Wall to front face** = 120mm

## Technical Specifications

**Materials:** Aluminium

**Connections:** ½" Flow and Return

**Test pressure:** 9 Bar

**Testing authority:** EN442

**Max operation pressure:** 6 Bar

**Max working temperature:** 95c

These can be cleaned using a soft damp cloth with a non-abrasive cleaning product.



**PLEASE NOTE:** That in accordance with Part L1 2006 of the Building Regulations and BS7593:1992 code of practice for the treatment of hot water and central heating systems, we recommend flushing the heating system before installation of new radiators and then adding the correct quantity and type of inhibitor for use with the radiator and system to prevent corrosion. Damage caused to systems not protected by a suitable inhibitor will not be covered by the manufacturer warranty. It is the responsibility of the installer to ensure the correct use and suitability of the fixings provided. No liability for costs or damages arising from failure to do so can be accepted.

# Installation Instructions

---



Review instructions carefully before installation.

Installation should be completed by a suitably qualified person.

Please dispose of packaging in a responsible manner.

---

## Brackets

Brackets are usually placed one section in from either end, top and bottom.



## Manual & Installation Instructions

Heater Controller H+h  
& Temperature Sensor

HOME



HEAT SYSTEM



# Content list

---



Heater Controller - Horizontal



Temperature Sensor / Remote Controller

---

## Kit Content

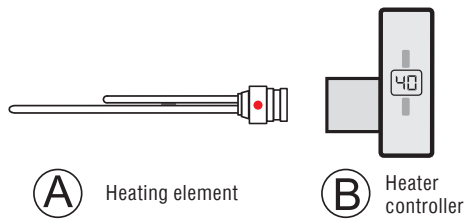

(A) Heating element

(B) Heater controller

## Side Connection

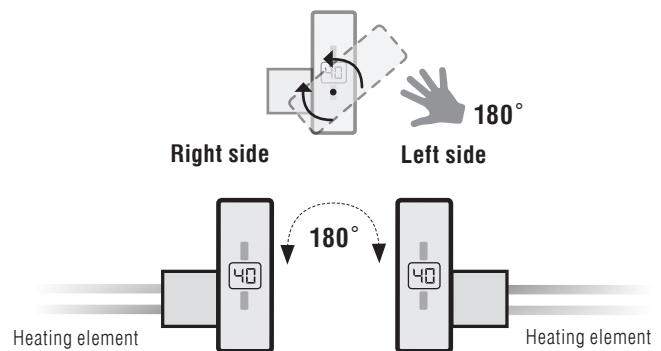

# Safety

---



**1. The heater should be installed by a qualified person.**

2. Bathroom radiators fitted with electric heaters should be fixed not less than 60 cm from a bath, shower or wash basin, and never above a bath.

3. For the heater permanently connected (hard wire) there must be applied a cut-off device from the mains. Such a device must disconnect the heater from the supply mains in 2 poles, with contact separation of at least 3 mm.

4. This appliance can be used by children aged from 8 years and above and persons with reduced physical, sensory or mental capabilities or lack of experience and knowledge if they have been given supervision or instruction concerning use of the appliance in a safe way and understand the hazards involved

5. Children shall not play with the appliance. Cleaning and user maintenance shall not be made by children without supervision.

**6. The heater MUST BE DISCONNECTED before cleaning the casing. AVOID SOAKING THE CASING.**

7. One radiator valve must always be open when a heater is in use (liquid thermal expansion).

**CAUTION:** To avoid the risk of fire or electric shock the heater should be protected from water spray or flooding. This appliance is not intended for use by persons (including children) of limited physical, sensory or mental abilities, or persons inexperienced or not familiar with the appliance, unless supervised or instructed on the appliance use by persons responsible for their safety. Particular attention should be paid to children, to preclude playing with the appliance by them. Exclamation mark on triangular field signals: **information important for the user.**

**CAUTION: Electric shock hazard!**, lightning mark ended with arrow on triangular field

**CAUTION:** in order to reduce electric shock hazard, do not remove the casing (nor its rear cover). There are no user-serviceable parts inside the appliance; the product must be returned to the manufacturer for repair via the distributor who sold the product.

**GUARANTEE TERMS:** Guarantee is granted by manufacturer for 24 months period starting from date of sale, but no longer than 36 months from date of the heater manufacture. Defects revealed within this period, resulting from a fault of manufacturer will be repaired free of charge or the item replaced with new, equivalent one. Term of complaints' investigation up to 14 (fourteen) days from date of submission to the manufacturer.

**Guarantee does not cover:**

1. Using of product in a manner noncompliant with attached instructions.

2. Any visible damage to the heating element or controller due to improper use. Damaging of manufacturer's seals makes the guarantee null and void.

**In the event that Heatpol are unable to repair or replace this product we reserve the right to refund the purchase price as an alternative.**

**CAUTION:** The guarantee card should be legibly filled in retail outlet. Any corrections on the guarantee card will invalidate the guarantee. Guarantee card valid only with proof of purchase.

# User Instructions

## A Preparing the temperature sensor

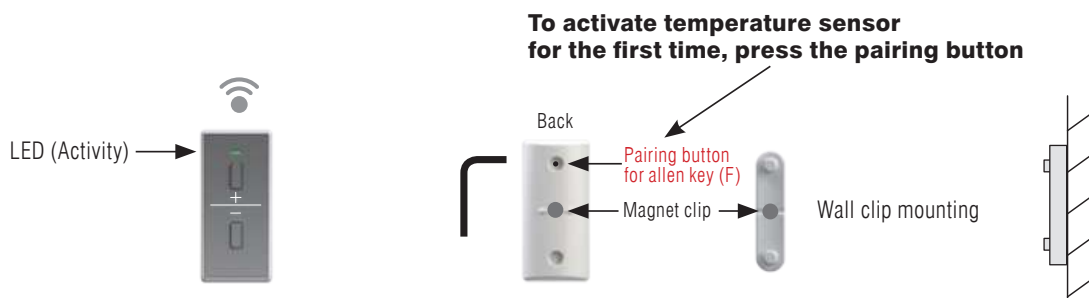

## B Locate suitable place to mount temperature sensor

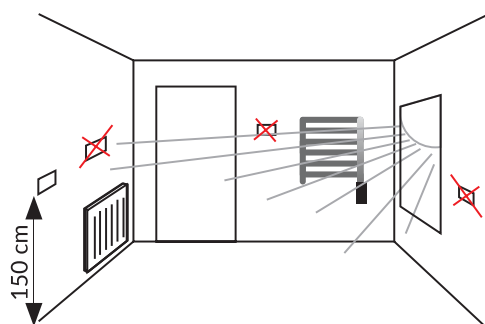

Do not place the temperature sensor:

- over the radiators
- next to doors
- in sunny places

## C Mounting in radiators

Central heating system

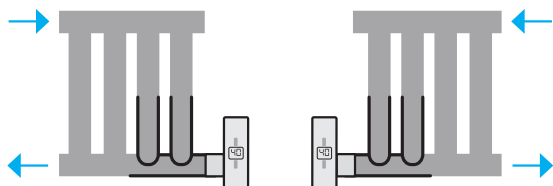

Electric radiators

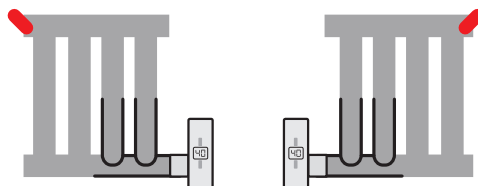

The electric heater must have a safety valve

# Installation Instructions

**A**



HEALTH & SAFETY

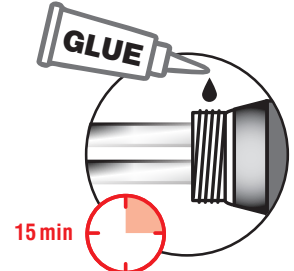



GLUE

15 min

Before you apply the heating element, spread the Loctite glue (included in the set) on the middle of the thread circumference.

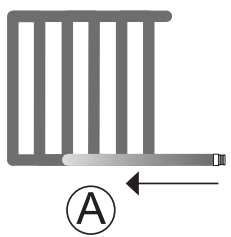
**B**



Do not play in yet

**C**

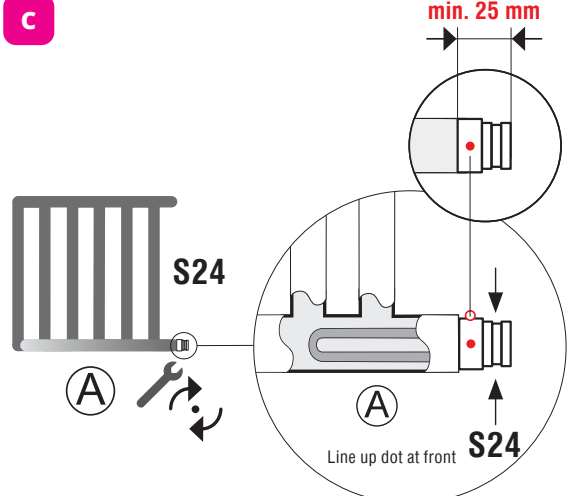

min. 25 mm

S24

A

Line up dot at front

S24

**D**

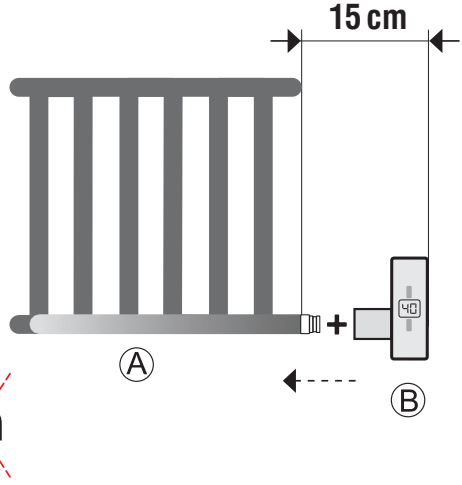

15 cm

A

B

230V

**E**

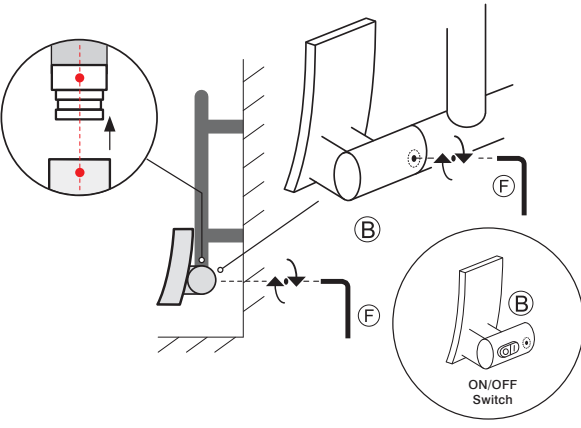

B

F

ON/OFF Switch

**F** Electric radiators

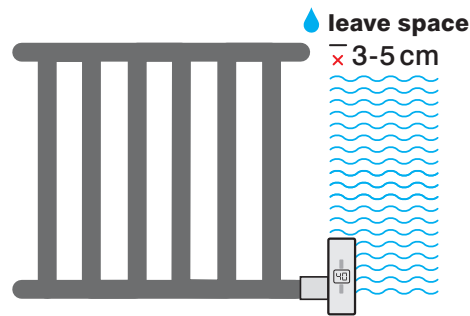

leave space  
x 3-5 cm



# Installation Instructions

## G Central heating system

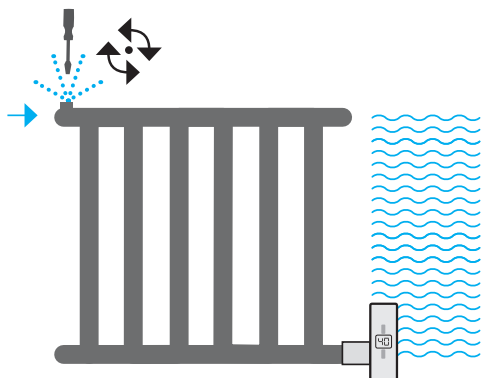

## H

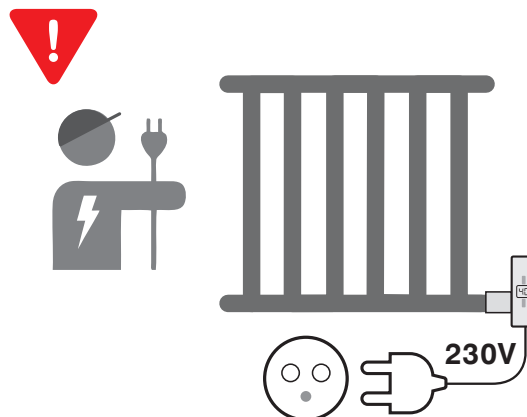

## I

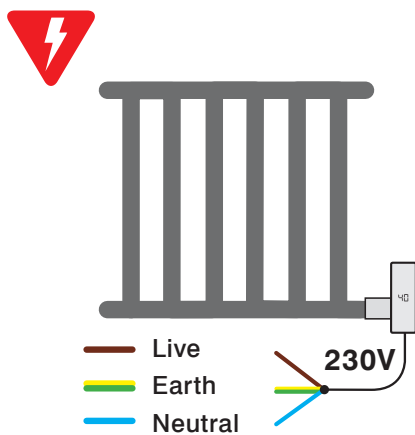

For the heater permanently connected (hard wire) there must be applied a cut-off device from the mains. Such a device must disconnect the heater from the supply mains in 2 poles, with contact separation of at least 3 mm from the main supply.

# WiFi Configuration

## 1 Heater controller



← Heater controller display

When the heater is connected to the mains properly, the red light will flash on the controller display.

## 2 WiFi

The heater is ready for WiFi configuration.

## 3 Create a free Supla account

Go to [supla.org](https://supla.org) and create a free supla account and follow the attached instructions.



Download the app



System requirements ANDROID 3.1/IOS 8.2 or the latest version. Install the application on your devices. The app will guide you through the individual installation steps.



# Errors



**ATTENTION: Signalling improper installation or improper use:**

- E1 Lack of water (or wrong choice of heat-ing element to the heater)
- E2 Damaged heating element (or no power cuircuit)
- E3 No communication to the remote controller if paired

**DO NOT DISCONNECT! Controller from heating element, when connected to the power supply**



# Temperature Sensor Remote



**ATTENTION:** The temperature sensor can be used as a remote controller instead of your Smartphone

## 1 Run the controller

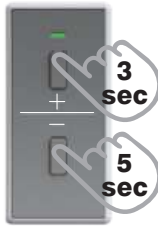

### Run the controller

Hold upper button for 3 seconds

### Switch off the controller

Hold lower button for 5 seconds

**40° C**

Standard heating temperature

## 2 Select temperature

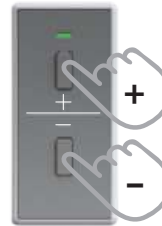

**30° C - 65° C**

Select temperature

## 3 TURBO mode activation



### TURBO mode

**activation - max heating temperature**  
Hold button for 3 seconds

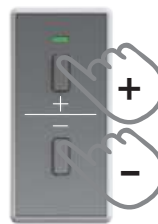

**b1-b2-b3**

Max heating temperature, selection for 1/2/3 hours

**b0**

Off selection

# New Remote Controller Pairing

When you buy a new heating element with a remote controller it will already be paired. You do not need to pair it again. In case you purchase a new temperature sensor/remote controller - you need to pair it:

Prepare remote controller + allen key for use

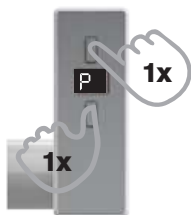

**Press once upper and lower button together**



**Hold 3 sec.**  
Start countdown

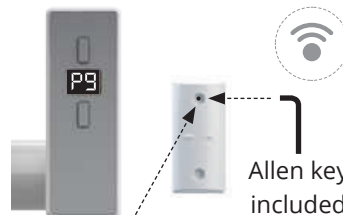

**During countdown within 30 seconds** Reverse remote controller. Push pairing button!



**Pairing finished!**  
Remote controller is already working

# Terms and Conditions

---

You must immediately remove all packaging, inspect the goods and notify us of any damage to the goods within 3 days of delivery. We shall have no obligation to replace or repair damaged goods in the event of failure by the Buyer to comply with this provision. Radiators which are off an unacceptable standard or are damaged must not be installed. If any items is installed it will be treated as being as accepted as received.

Damaged goods being returned will only be collected from your delivery address, unless otherwise agreed in writing. Any other goods, which we accept back, are to be returned by you to our place of business at your expense.

Items will be accepted as a return which have not been installed or damaged after delivery. We do not accept liability for any damages sustained after delivery. Goods should be returned in their original packaging, provided such packaging and goods are undamaged.

We may issue a credit note for goods which we accept as returned.

We may agree to provide you with replacement goods prior to collecting or receiving back the goods to be returned (whether faulty, damaged or otherwise) but only on the condition that: the replacement goods are paid for in full and we reserve the right to re-invoice you in the event that the returned goods are found to be in a worse condition than when they were originally received by you or where such goods have not been received back to us within 3 months of the replacement goods being received by yourselves. A re-stocking charge of 30% will be applied to all non-faulty stock items that wish to be returned. Special order and non-stock products cannot be cancelled. Where cancellation or alteration of orders is accepted by us, you may be required to pay a restocking charge, to cover administrative costs and collection costs (if applicable); such charges to be determined by us. If the goods we deliver are faulty or damaged, we will meet the cost of the return, as long as the fault is reported to us within 3 working days.

The goods will be deemed to have been accepted when they have been delivered and we may not accept claims for any visible defects found after installation.

We accept no liability for any cost incurred relating to the cost of installation.

We shall not be liable for any plumber's costs, decorator's costs, transport costs, late penalties, or any other costs, as a direct or indirect result of (i) any defect in the goods (including but not limited to any manufacturing faults, such as leaks, that become apparent on or after installation) or (ii) late delivery of the goods.

**GUARANTEES AND LIABILITIES** – we are not the manufacturer of this product we will take all reasonable endeavours to make over to you the benefit of any warranty or guarantee given by the manufacturers. The item must have been fitted in accordance with British and or European standards as well as these fitting instructions.

