

# Electric Panel Heater

## Instruction Manual

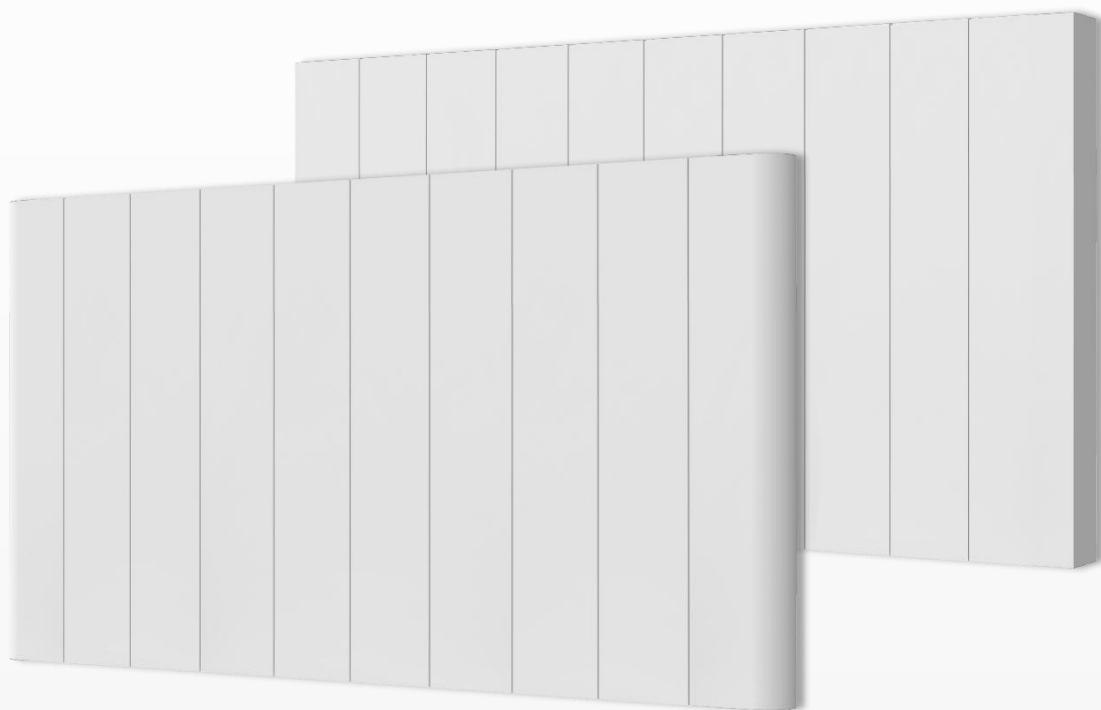

**MAIA&NIKA-H**

---

# Table of contents

---

## 1. Safety & Warnings

## 2. Technical Specifications

## 3. Installation

- 3.1 Fixings
- 3.2 Wall mounting instructions
- 3.3 Free Standing Instructions

## 4. Control Panel

- 4.1 Standby Mode
- 4.2 Heating Mode
- 4.3 Child lock
- 4.4 Supplementary functions
- 4.5 Tilt Protection
- 4.6 Reset to Defaults

## 5. Connecting to WiFi

- 5.1 Downloading the App
- 5.2 Connecting to the App
- 5.3 Adding Devices

## 6. Using the APP

- 6.1 Home Overview
- 6.2 Control Interface
- 6.3 Choose Mode

## 7. Device Setting

- 7.1 Child Lock
- 7.2 Temperature Compensation
- 7.3 Heat Plus
- 7.4 LST Setting
- 7.5 Open Window Detection
- 7.6 Holiday Time Setting

## 8. Disposal

**Read this manual carefully before using or installation the device.  
Keep the manual for future reference.**

 **Warning: This device must be installed by a licensed electrician.**

## 1. SAFETY & WARNINGS

- This appliance can be used by children aged from 8 years and above and persons with reduced physical, sensory or mental capabilities or lack of experience and knowledge if they have been given supervision or instruction concerning the use of the appliance in a safe way and understand the hazards involved. Children shall not play with the appliance. Cleaning and user maintenance shall not be made by children without supervision.
- Children of less than 3 years should be kept away unless continuously supervised. Children aged from 3 years and less than 8 years shall only switch on/off the appliance provided that it has been placed or installed in its intended normal operating position and they have been given supervision or instruction concerning use of the appliance in a safe way and understand the hazards involved. Children aged from 3 years and less than 8 years shall not plug in, regulate, or clean the appliance, or perform maintenance.
- Do not use the device in enclosed spaces if persons are present who cannot leave the room independently and are not under constant supervision
- In order to avoid overheating, do not cover the radiator.
- In order to avoid a hazard due to inadvertent re-setting of the thermal cut-out, this appliance must not be supplied through an external switching device, such as a timer, or connected to a circuit that is regularly switched on and off by the utility.
- Some parts of this product can become very hot and cause burns. Do not touch the surface when in operation. Do not install close to curtains or other combustible materials. Particular attention should be given where children and vulnerable adults are present.
- Keep the power cable away from all hot parts of the appliance.
- Do not use the device if you detect damage to the mains plug or power cable. If the supply cord is damaged, it must be replaced by the manufacturer, its service agent or similarly qualified persons to avoid a hazard.
- All repairs and servicing must be carried out by a qualified person. To avoid danger any repairs must be completed by the manufacturer, a service agent of the manufacturer or a similarly qualified person.
- Make sure the voltage indicated on the rating plate for this appliance corresponds to your power outlet.
- Do not use this device in the immediate surroundings of a bath, shower, swimming pool or any other water container. Risk of electric shock.
- The device must not be located immediately below an electrical socket outlet.
- Do not use the device with wet or damp hands.
- No part of the appliance should be submersed in any type of liquid.
- Cleaning should be carried out using a damp cloth only. No abrasive chemicals or materials should be used.
- Never insert fingers or other objects or body parts into the device. Risk of electric shock or injury.
- Do not use any accessories with this device. Use of accessories may cause damage or danger.

- Keep the device at a minimum distance of one metre from curtains and other flammable materials.
- The device must only be installed in an upright and fixed position in accordance with national installation rules.
- The device is for indoor use only.
- Do not use the radiator with a programmer, timer, separate remote control system or any other device that switches the heater on automatically, since a fire risk exists if the heater is covered or positioned incorrectly.
- Make sure the minimum safety distances from walls and objects stated in the installation instructions are observed at all times. This is very important to prevent damage to walls, furniture and soft furnishings and to prevent the product overheating.
- Do not use the device in rooms where contact with flammable or potentially explosive materials like dust, gas or vapour cannot be avoided.
- Do not use in rooms or environments that have a corrosive atmosphere.
- Do not operate the device when wet. If the device gets wet during cleaning, allow it to dry out before using.
- Do not expose the device to water jets.
- Do not transport the device during operation.
- Do not sit on the device.
- Do not overload the socket used to power the device.
- Before carrying out maintenance, care or repair work on the device, ensure the device is unplugged. Do not use the cable to tug the plug from the socket. Hold the plug by its housing and pull.
- Switch the device off and disconnect the power cable from the mains socket when the device is not in use.
- Allow the device to cool down before touching or transporting the device, or attempting maintenance work.
- The device must be placed where the switches and controllers cannot be touched by a person in a bathtub or shower.

## 2. TECHNICAL SPECIFICATIONS

Code	MAIA/NIKA-H
Heating element	X shaped Aluminum
Voltage	230V AC / 50Hz
Wattage	700W, 1000W, 1500W, 2000W
Temperature setting	7–30 °C
IP rating	IPX0
Appliance class	Class I
Power cable length	1.5m
WiFi frequency (2.4G band)	
Operation frequency	2400-2483.5MHz
Max RF power transmitted	17.21dBm (52.6mW) < 20dBm (100mW)

## 3 INSTALLATION

### 3.1 Fixings

Before installing, check that all fixings are complete, and the product is intact. The radiator should only be wall mounted with the manufacturer's fixings.

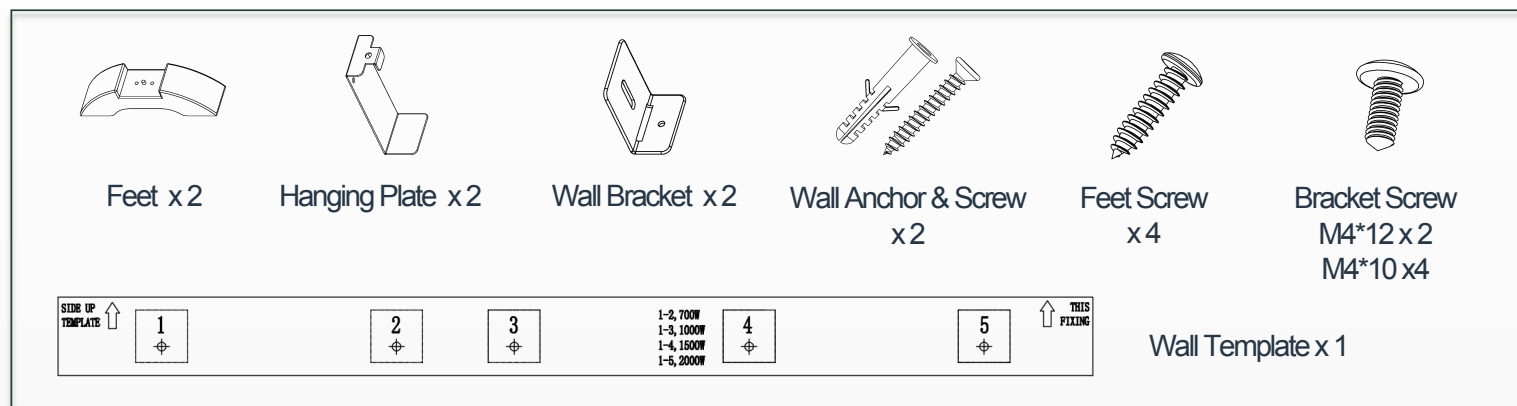

### 3.2 Wall Mounting Instructions

Warning – Before switching on the appliance make sure the radiator is correctly fixed and is secure to the wall.

#### 3.2.1 Prepare the heater

Attach the hanging plates to the back of the heater by using two M4\*10 bracket screws for each plate, as illustrated below.

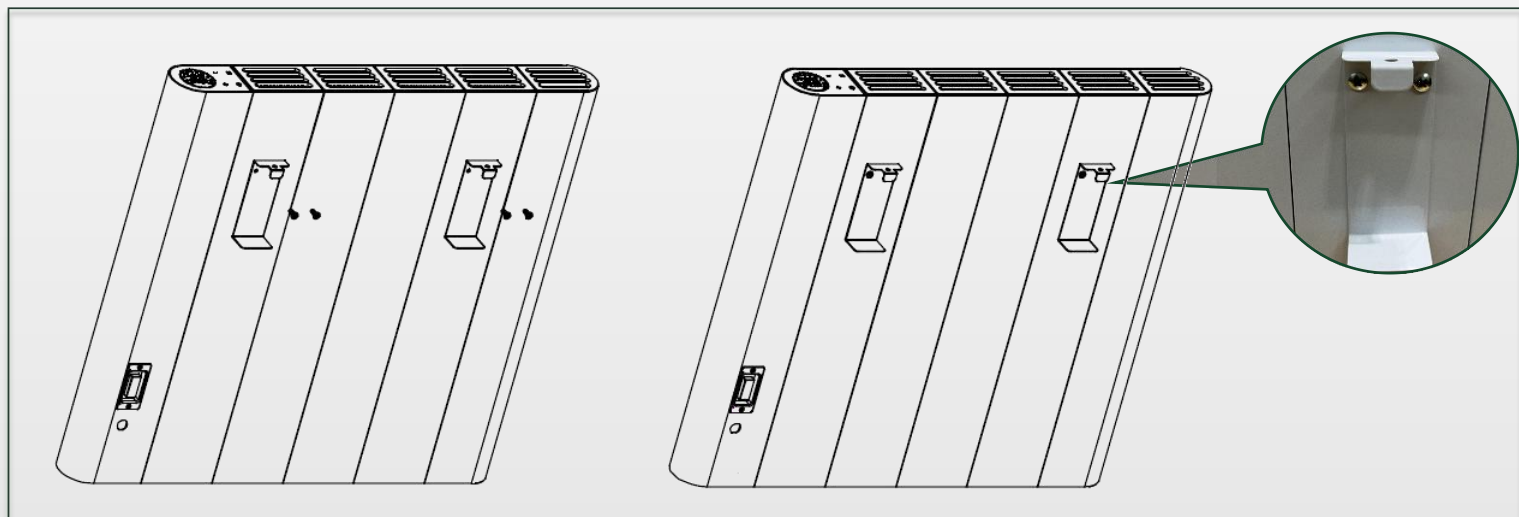

#### 3.2.2 Prepare the wall

Choose the mounting position, respecting the minimum distances from surrounding walls, ceilings or fixed objects shown in the diagram below: at least 20cm from the top, 20cm from the sides, 10cm from the floor, and 60cm from the front. Mounting closer than recommended can cause overheating of the device and damage to surrounding objects and surfaces.

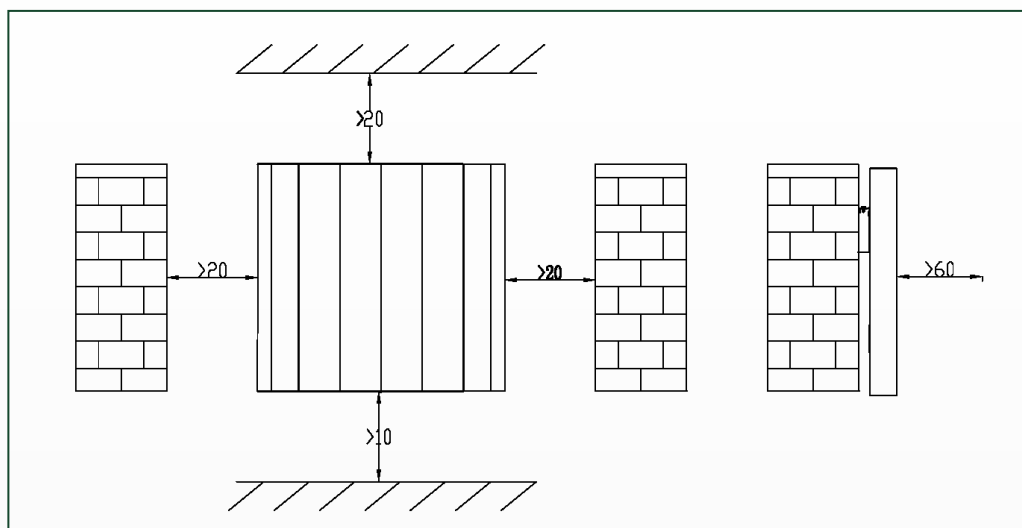

Fix the wall brackets:

- Using the template, make two marks on the wall according to the product size.
- Using a 6mm drill bit, drill two holes where you make your marks.
- Knock a wall plug into each hole using a hammer.
- Position the wall hangers over the holes and use two wall screws to fix them in place.

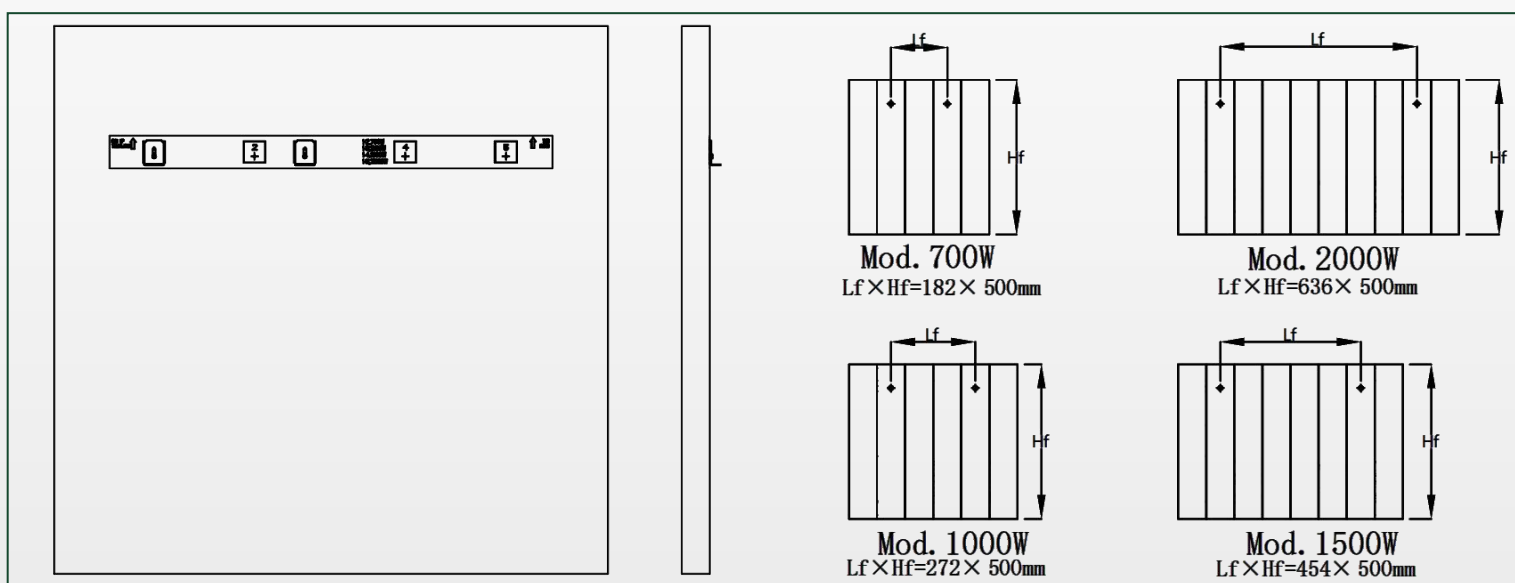

700W

2000W

1500W

1000W

**Drill hole distances by product size:**

Model	Lf(mm)	Hf(mm)
700W	182	500
1000W	272	500
1500W	454	500
2000W	636	500

### 3.2.3 Hang the heater

Hang the heater on the wall brackets and fix in place with two M4\*12 bracket screws.

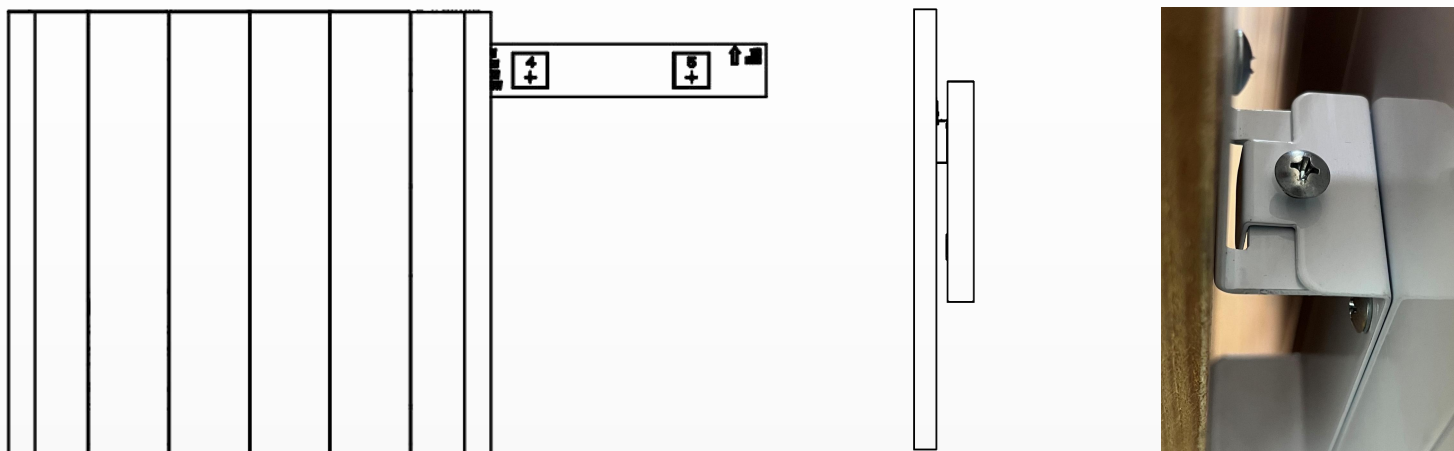

### 3.3 Free Standing Instructions

To use the heater free standing, you must first affix the feet:

- a) Make sure the heater is off and turn the heater upside down.
- b) Align the holes on the feet with the holes on the base of the heater.
- c) Use two feet screws to attach each foot.

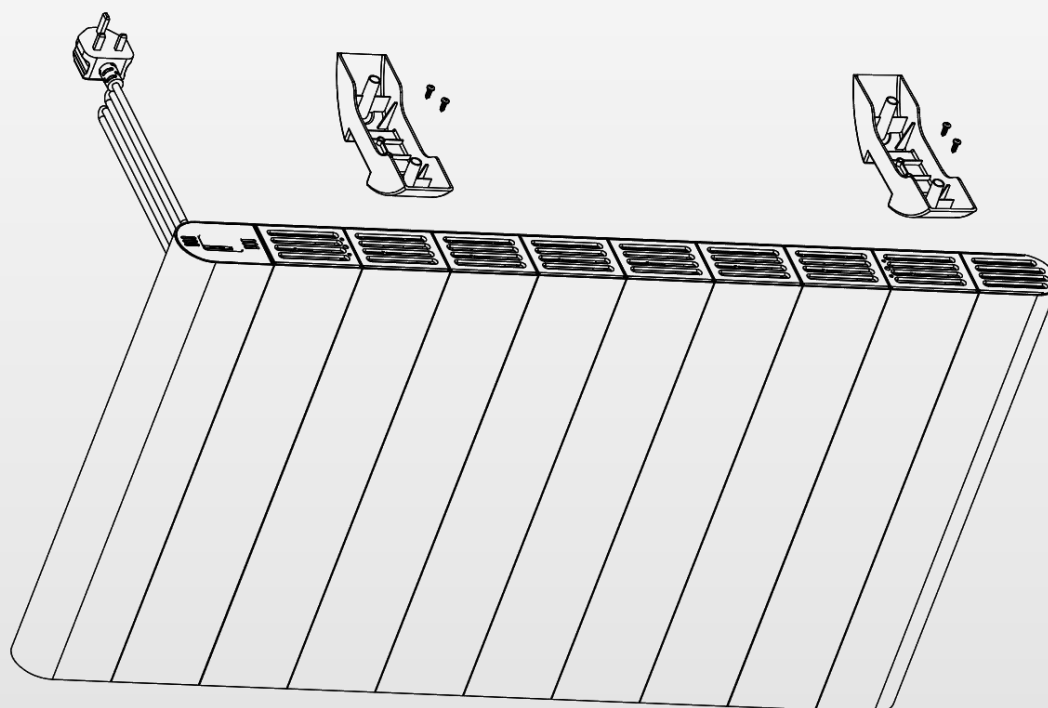

**Warning:** To prevent potential safety hazards, it is recommended that grounding and short circuit measurements be performed after installation of the device. This should be done by a licensed electrician.

## 4. CONTROL PANEL

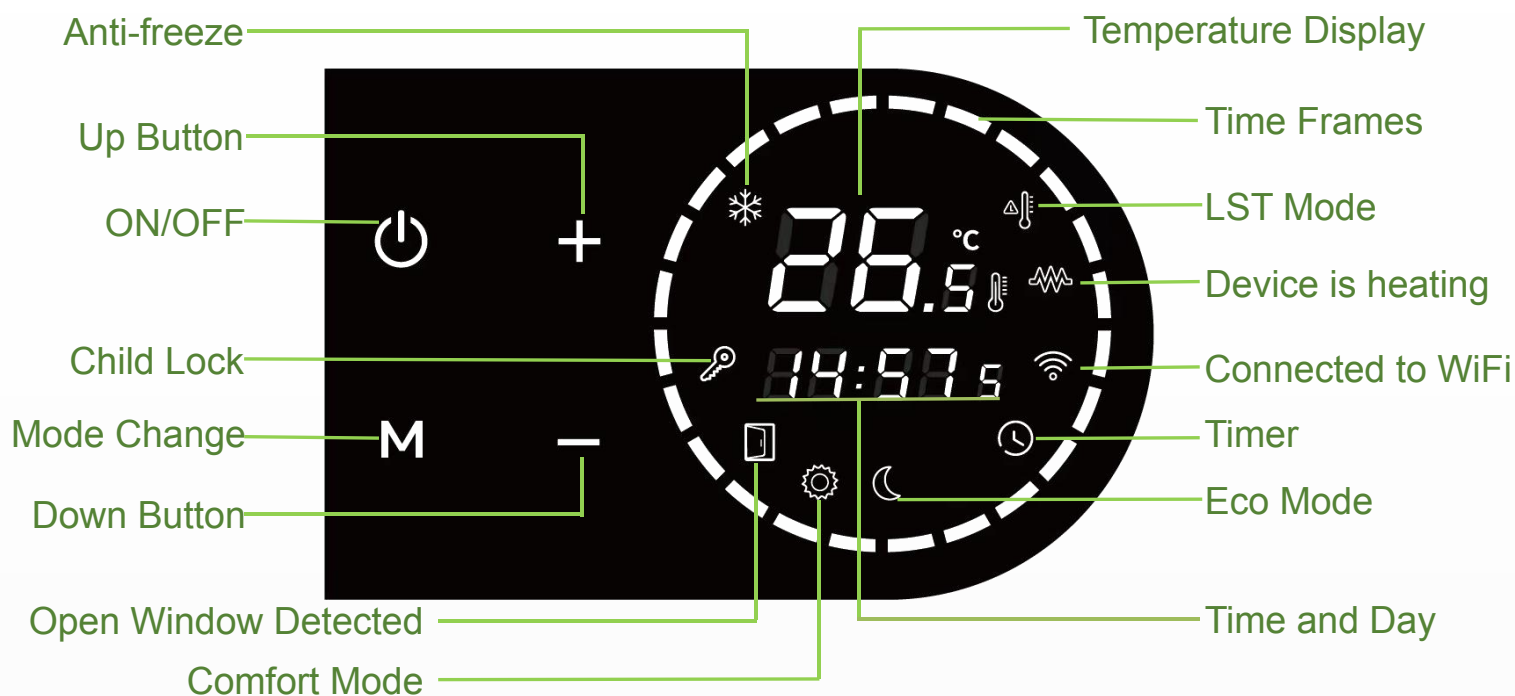

The controller has below functional modes:

### 4.1 Standby Mode

### 4.2 Heating Mode

#### 4.2.1 Comfort Mode

#### 4.2.2 Eco Mode

#### 4.2.3 Anti-Freeze Mode

#### 4.2.4 Timer Mode

### 4.3 Child lock

### 4.4 Supplementary functions

#### 4.4.1 Temperature Compensation

#### 4.4.2 Open Window Detection

#### 4.4.3 Heat Plus Mode

#### 4.4.4 WIFI Mode

### 4.5 Reset to Defaults

## **Power Switch**

Before first use, the radiator must be switched on at the mechanical switch at the back of the unit.

This switch must be left in the ON position if you want the radiator to remember its set times and programs.







## 4.1 Standby Mode

When the radiator first switches on it appears in standby mode and the radiator will not heat. You can use the  button to switch between standby and heating modes.

## 4.2 Heating Mode



Press the  button to switch the radiator on. Press the **M** button to change the heating mode. Cycle through: Comfort mode→ECO mode→Anti-Freeze mode→Timer mode

### 4.2.1 Comfort Mode

- Press the  button to enter the comfort mode. The default set temp is 19°C.
- Set temperature can be adjusted by using the **+** and **-** buttons. The range is 7-30°C in steps of 0.5°C. Press and hold the button to speed up.
- Symbol  will be displayed when heating and disappear when it is not heating.



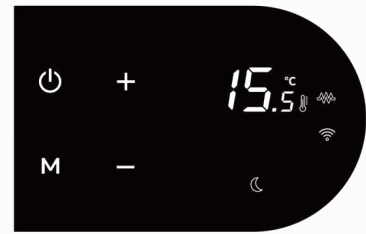

### 4.2.2 Eco Mode

- Press the **M** button to enter the Eco mode. When the icon  displays on the screen, you are in Eco mode. The default set temperature is 15.5°C.
- Set temperature can be adjusted by using the **+** and **-** buttons. The range is 7-30°C in steps of 0.5°C. Press and hold the button to speed up.
- Symbol  will be displayed when heating and disappear when it is not heating.



### 4.2.3 Anti-Freeze Mode

- Press the **M** button to enter the anti-freeze mode. When the icon  displays on the screen, you are in Anti-Freeze mode. Anti-freeze mode is set to 7°C. This is not adjustable.
- Symbol  will be displayed when heating and disappear when it is not heating.

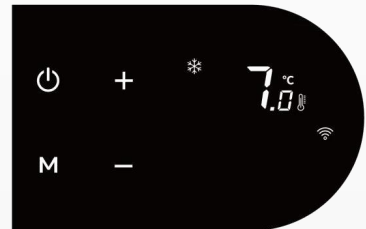

### 4.2.4 Timer Mode

- Press the **M** button to enter the timer mode. When the icon  displays on the screen, you are in timer mode. 00:00 will be displayed when power is on for the first time.
- Press and hold the **M** button for 3S to set the time. Press **M** to switch settings: hour setting→minute setting→day of week setting→day program setting→confirm.
- Hour setting: Press **+** or **-** to set the hours, the setting range is 0~23 in steps of 1H. Press and hold the button to speed up. (Figure-1)
- Minute setting: Press **+** or **-** to set the minutes, the setting range is 0~59 in steps of 1min. Press and hold the button to speed up. (Figure-2)



- Day of week setting: Press **+** or **-** to set the day of week, the setting range is 1~7 in steps of 1day. where 1 = Monday, 2 = Tuesday and so on. Press and hold the button to speed up. (Figure-3)

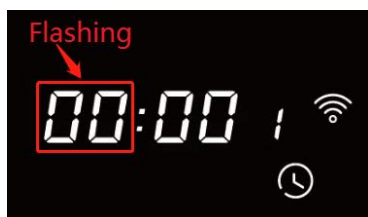

Figure-1



Figure-2



Figure-3

- Day program setting: P1-P7 all default to Eco mode. The timer allows you to set a different program for every day of the week. P1 is the schedule for Monday, P2 is the schedule for Tuesday, and so on. Each program consists of 24 hourly slots where you can set either comfort or Eco mode. The radiator will heat at the temperatures you set on comfort and eco mode.



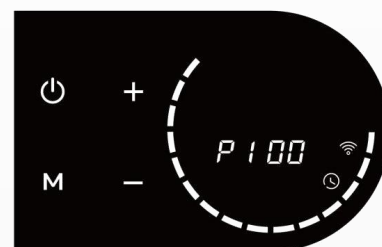

- Follow the instructions above for setting the time. When P1 appears on the screen, you are ready to start setting your program:

- P1 and 00 will be on the screen. This means you are choosing a mode for midnight on Monday morning. Press and hold the **M** button for 3S to set the mode of each hour.
- Press **+** to choose comfort mode, shown ; Or **-** to choose Eco mode, shown . Each operation will automatically increase by 1H, and the bars circle on the screen will change to reflect your choice.



For example: Change P1 to comfor mode from 7:00 to 21:00 (other time Eco mode).

- In the TIMER mode, the setting time is displayed.

- Comfort mode: the  bar flashes and stays for 3 seconds, and the  icon displays on the screen.
- ECO mode: the  bar flashes and stays for 1 seconds, and the  icon displays on the screen.

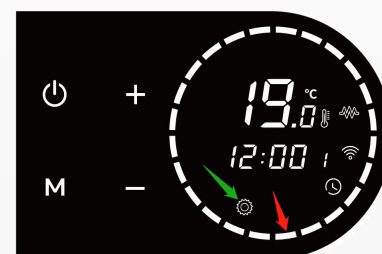



For example: The current time is 12:00, and the corresponding mode is comfort, the  icon displays (green arrow) and bar  flashes and stays for 3 seconds(red arrow).

**In the running state of Timer mode, press **+** or **-** to quickly switch the mode of the current hour.**

### 4.3 Child Lock

Use this function to prevent any change in the thermostat setting.

Press and hold the **+** and **-** buttons for 3 seconds to lock the display. The  icon will appear and all buttons will be locked except the standby button .

Repeat the same procedure to unlock it.



## 4.4 Supplementary functions

The settings menu allows you to enable, disable and configure all the radiator's supplementary functions.

Press  to put the radiator into standby mode and hold down **+** for 10 seconds to enter the settings menu.

Press **M** button to switch functions: Temperature compensation→Open window detection→Heat Plus mode→WiFi mode

### 4.4.1 Temperature Compensation

The temperature compensation setting allows users to adjust for any discrepancy between the average room temperature and the temperature sensed by the thermostat. For instance, if the temperature in the room is 18°C, but the radiator is sensing 16°C, a compensation factor of +2°C will offset the difference. Press the **+** or **-** to adjust. The setting range is from -5~5°C in steps of 1°C (The default set is -2°C).

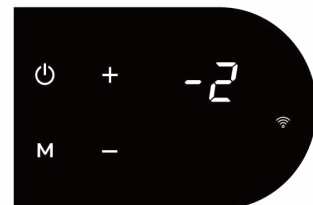

### 4.4.2 Open Window Detection

This function enables the automatic detection of an open window when the radiator is working.

- Press the **+** or **-** button to select, there are three options for the open window detection function: oF, 60 minutes and 90 minutes (The default set is oF).



- If the radiator detects a sudden drop in temperature (2°C or more within 5 minutes), the  icon will appear and the radiator will switch to anti-freeze temperature (fixed 7°C) for 60/90 minutes to prevent energy wastage as heat escapes through the window.



- It will revert back to the previous mode after heating for 60/90 minutes. If the temperature drops by 2°C within 5 minutes again, the radiator will continue to switch to anti-freeze temperature (fixed 7°C), then cycle through.

### 4.4.3 Heat Plus Mode

This is the radiator surface temperature, it means that it can be heated for a longer time before it stops working, which will heat up the room more quickly.

When the radiator surface temperature hit the selected temperature, it will stop working and it will work again once the surface temperature lower than the selected temperature.



- Press the **+** or **-** to set the temperatures. The setting range is 65~75°C in steps of 5 °C. (The default set is 70°C).

### 4.4.4 WIFI Mode

This setting allows you to enable or disable the radiator's connection to WiFi. Disabling the connection is temporary: if you have already added the radiator to your app account, disabling the connection will not remove it. You will be able to control via the app as soon as you re-enable the connection.





- Press the **+** or **-** to switch. Select "oN" to enable and "oF" to disable. (The default set is oN).

## 4.5 Tilt Protection

As a safety feature, this radiator is fitted with a tilt protection function that automatically places the radiator into standby mode if the appliance fell down.

When the appliance is returned to an upright position, normal operation will then be resumed.

## 4.6 Reset to Defaults

Press  to put the radiator in standby mode. Press and hold the  key for 10 seconds to restore the device to default settings. The full screen will be displayed for 3 seconds and enter to power off state. Press  to turn on. The comfort mode temperature is 19°C, the Eco temperature is 15.5°C, the anti-freeze mode temperature is 7°C, the time display "0000" and the week display "1"; P1-P7 are the default settings of the Eco mode, the temperature compensation is "-2", and the open window detection is "oF". LST function is "oF", WIFI function is "on".

## 5. CONNECTING TO WIFI

### 5.1 Downloading the App

Download the APP onto your smart phone. You can find the app by scanning the QR code below or searching "INOW" in the Google Play or Apple app store. Install and follow the app's instructions to create an account.



**INOW**

### 5.2 Connecting to the App

To put the radiator in pairing mode, press  to enter power off mode and hold down **M** button for 3 seconds until the screen switches to the connection screen. This begins a 99 seconds count down, giving you 99 seconds to make the connection on the app.

### 5.3 Adding devices

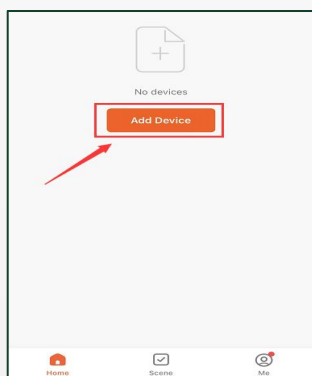

Click "Add device"

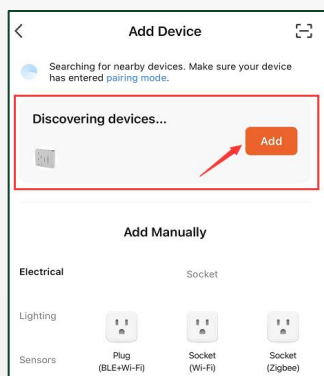

Click "Auto scan"

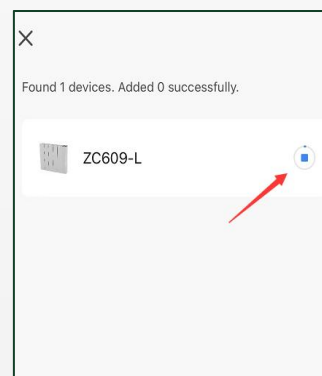

Click "Add"

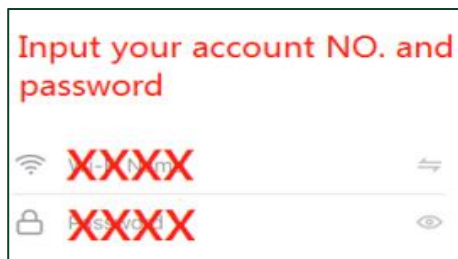

**Enter your WiFi password**

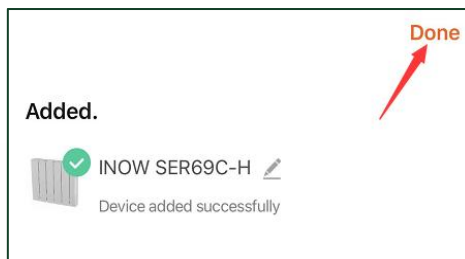

**Begin connecting and added successfully**

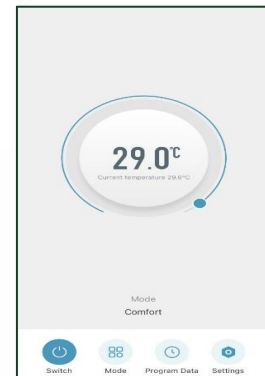

If the heater succeeds to connect, "PS" will be shown on the display.

If the heater fails to connect, "FA" will be shown on the display.



## Troubleshooting

Problem	Action
the thermostat sensor has become disconnected	Er is displaying

## 6. USING THE APP

### 6.1 Home Overview

You can use the INOW app to control multiple devices. All devices are displayed on the home screen with their status.

Possible statuses:

- Online – Heater will respond to app commands.
- Offline – Device is turned off at wall or power switch. It cannot be controlled by the app.

### 6.2 Control Interface

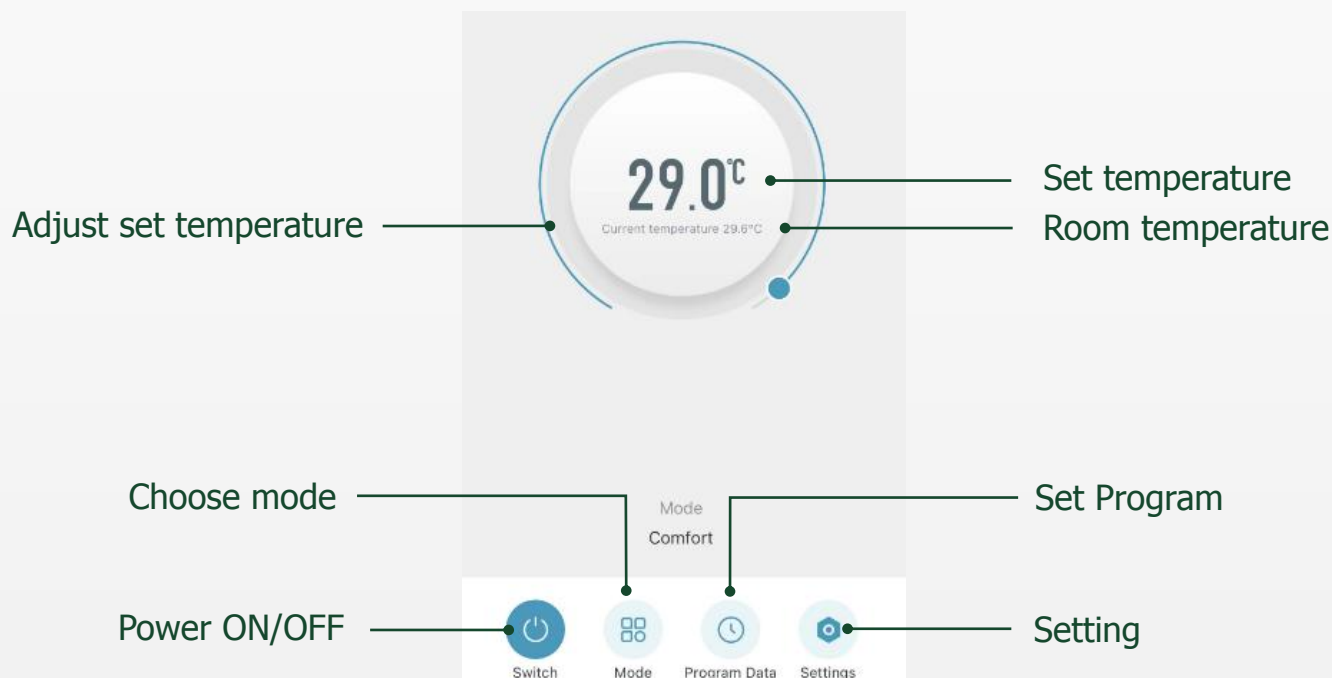

### 6.3 Choose Mode

Tap the mode button on the interface to choose mode. The six options correspond to the six modes on the control panel. Comfort, Eco, Anti-Freeze, Program, Auto and Holiday mode.

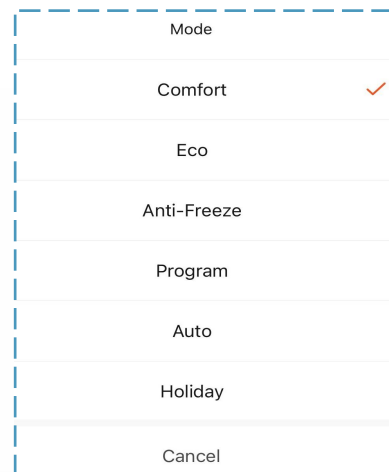

#### 6.3.1 Comfort & Eco Mode

In comfort and Eco mode, simply use the sliding dial to adjust the set room temp.

#### 6.3.2 Anti-Freeze Mode

In anti-freeze mode, it is set to maintain a low room temperature for energy saving when you are absent from the house. 7°C displays on the APP, it can't be adjustable.

#### 6.3.3 Program Mode

Tap the program data icon on the control interface to configure a program.

A program consists of 24 hourly intervals for each day, which you can set to Comfort or Eco temperature.

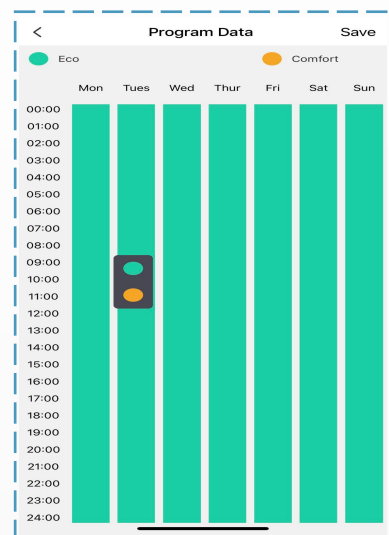

Tap the interval to choose Comfort (yellow bar) or Eco (green bar). You can drag the start and end times of each mode block to make setting your program quick and easy.

#### 6.3.4 Auto Mode

The device will work under automatic preset program. Default data list as below:

Period	Icon	Time	Temperature
Work day (Monday-Friday)	1	6:00	19.0°C
	2	8:00	15.5°C
	3	17:30	19.0°C
	4	22:00	15.5°C
Weekend (Saturday-Sunday)	1	8:00	19.0°C
	2	10:00	15.5°C
	3	17:00	19.0°C
	4	22:00	15.5°C

#### 6.3.5 Holiday Mode

To avoid having to adjust each radiator individually or add a different schedule, you can simply activate Holiday Mode. It'll suspend your schedules, hold the energy-saving temperature 7°C and prevent your home from freezing up. Once the holiday setting time ends, it will automatically return to the previous setting mode.

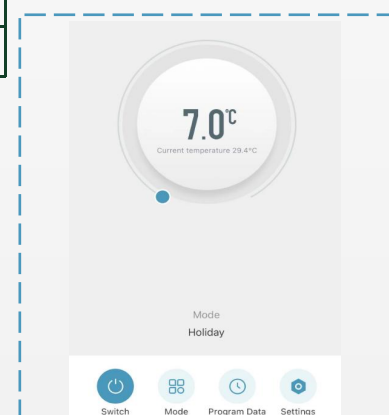

## 7. DEVICE SETTINGS

Tap the setting icon to view and adjust the radiator's settings. This menu allows you to configure several settings not available through the control dial.

### 7.1 Child Lock

Use the toggle switch to lock or unlock the radiator display.  displays on the screen when the device is locked.

### 7.2 Temperature Compensation

You can adjust the temperature compensation in steps of 1 °C, from -5 ~5 °C.

### 7.3 Heat Plus

There are Three options for Heat Plus settings: 65°C, 70°C, 75°C.

The default set is 70°C. For more rapid heating in some cold areas, you can set it to 65°C or 75°C.

### 7.4 LST Setting

There are Five options for LST settings: OFF, 40°C, 45°C, 50°C, 55°C.

The default set is off.

### 7.5 Open Window Detection

The  icon will appear and the radiator will switch to anti-freeze temperature to prevent energy wastage as heat escapes through the window.

### 7.6 Holiday Time Setting

Holiday time can be adjusted only when the Holiday Mode from the control interface is selected, the setting range is 1~60 days.

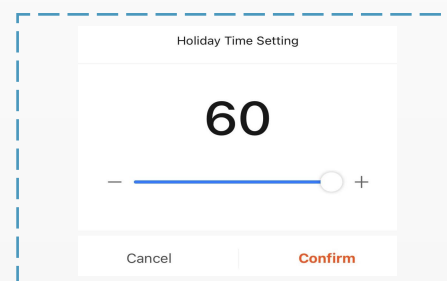
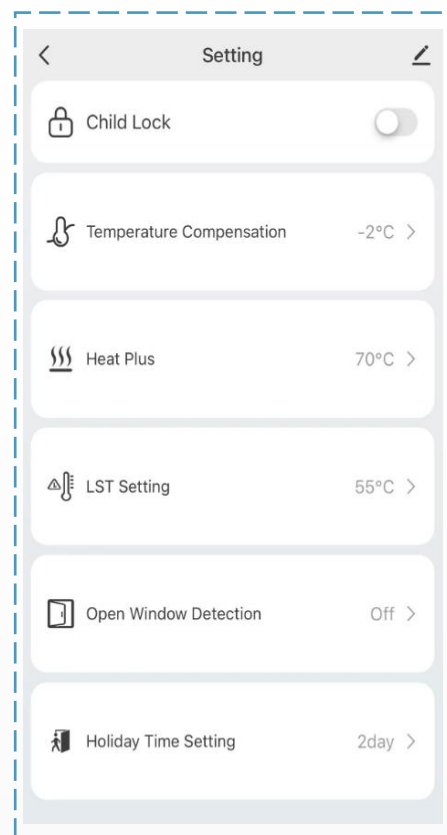

## 8. DISPOSAL



In accordance with WEEE Directive 2012/19/EU, the icon with the crossed-out waste bin on electrical or electronic equipment stipulates that this equipment must not be disposed of with household waste at the end of its life. You will find collection points for free return of waste electrical and electronic equipment in your vicinity. The addresses can be obtained from your local authority.

The separate collection of waste electrical and electronic equipment enables the re-use, recycling and other forms of recovery of waste equipment, and prevents any negative effects for the environment or human health.